

CILINDRICI

CYLINDRICAL



**CALETTAMENTO A CALDO
STANDARD**

SHRINK FIT HOLDERS STANDARD



**PORTA TESTINE FILETTATE
(CPY)**

FOR SCREWED MILLING CUTTERS



PORTAPINZA ER DIN6499

COLLET CHUCK FOR ER DIN6499

CARATTERISTICHE / SPECIFICATION / CARACTÉRISTIQUES/ TECHNISCHE DATEN

- CARATTERISTICHE TECNICHE**
- Costruiti in acciaio certificato in barre
 - Eseguiti trattamenti termici da fornitori certificati ISO 9001
 - Rettificati di precisione esternamente, internamente e nelle filettature delle ghiere chiudipinza
 - Controllati con strumenti di misura certificati
 - L'errore di concentricità massimo tra il cono e la sede utensile è 0.003 mm
 - Fornibili con o senza piano.

- CARACTÉRISTIQUES**
- Fabriqués en bar d'acier certifié.
 - Réalisation du traitement thermique par des fournisseurs certifiés ISO 9001.
 - Rectification de précision extérieurement, intérieurement et dans les filetages des écrous serre-pince.
 - Contrôlés par des instruments de mesure certifiés.
 - L'erreur de concentricité maximum entre le cône et le siège de l'outil est de 0.003 mm.
 - Peuvent être fournis avec ou sans meplat.

- TECHNICAL FEATURES**
- Manufactured with certificate steel
 - Heat treatments are performed by certified suppliers ISO 9001
 - Precision ground on shank, inside tapers and collet nut threads
 - Tested with high precision inspection and gaging equipment
 - The maximum error of concentricity between the cone and the seat of tool is 0.003 mm
 - Available with or without plan.

- MERKMALE**
- Gebaut aus zertifiziertem Stabstahl
 - Warmbehandlungen von Lieferanten mit Zeugnis ISO 9001
 - Genauigkeitgeschliffen aussen, innen und in den Gewinden der Spannmutter für den Zangenverschluss
 - Geprüft mit zertifizierten Messinstrumente
 - Die max konzentrische Abweichung zwischen Konus und Werkzeugsitz ist 0.003 mm
 - Erhältlich mit oder ohne top.



CALETTAMENTO A CALDO
CYLINDRICAL SHRINK FIT HOLDERS

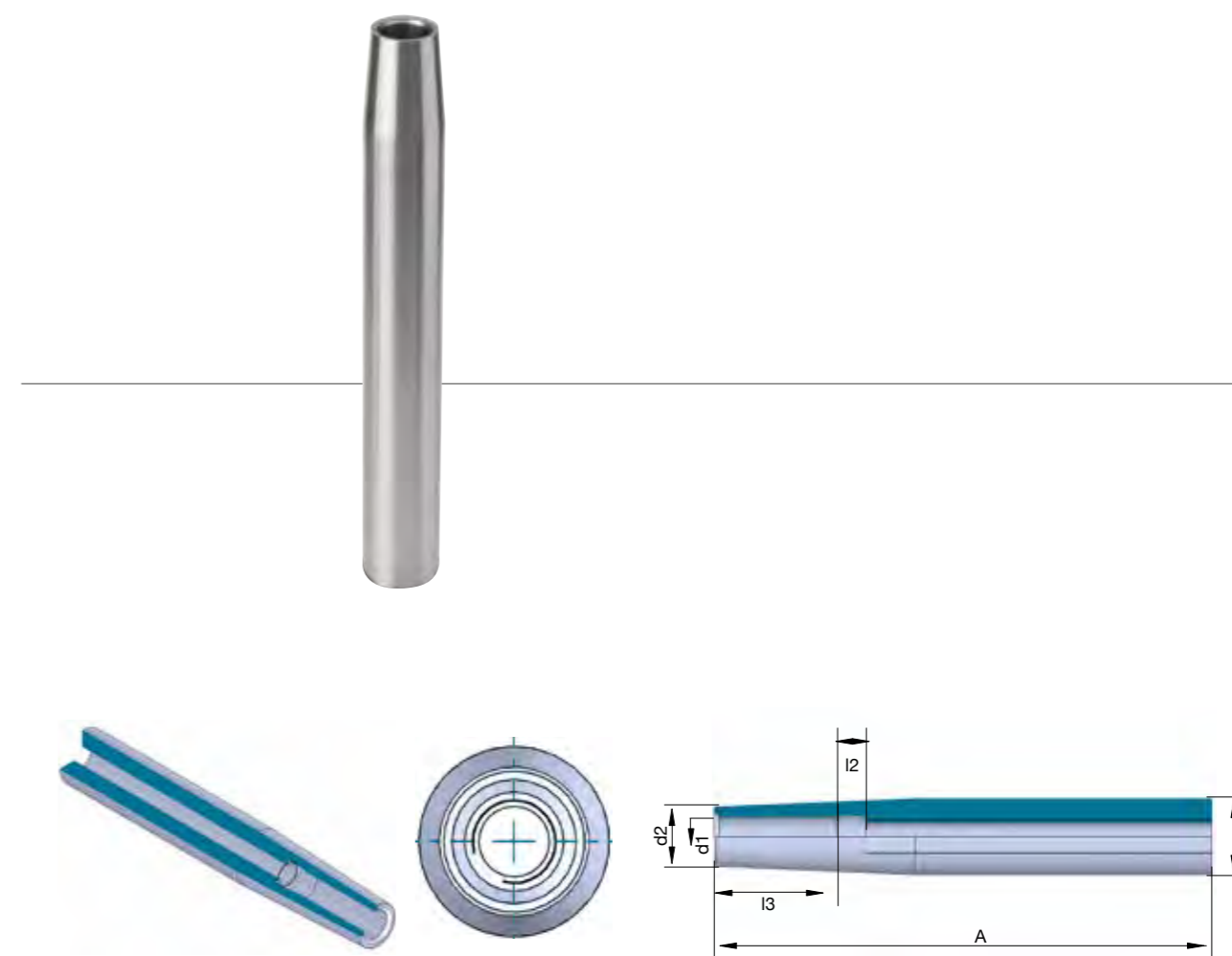

CALETTAMENTO A CALDO - CYLINDRICAL SHRINK FIT HOLDERS

Cod.	TYPE	d1	d2	D3	A	l2	l3	M
D12.150.CL3	D12 L150 CL3	3	8	12	150	-	12	M5
D12.150.CL4	D12 L150 CL4	4	8	12	150	-	16	M5
D16.150.CL3	D16 L150 CL3	3	10	16	150	-	12	M5
D16.150.CL4	D16 L150 CL4	4	10	16	150	-	16	M5
D16.150.CL5	D16 L150 CL5	5	10	16	150	-	20	M6
D16.150.CL6	D16 L150 CL6	6	10	16	150	10	26	M5
D20.150.CL3	D20 L150 CL3	3	10	20	150	-	12	M5
D20.150.CL4	D20 L150 CL4	4	10	20	150	-	16	M5
D20.150.CL5	D20 L150 CL5	5	10	20	150	-	20	M6
D20.150.CL6	D20 L150 CL6	6	10	20	150	10	26	M5
D20.150.CL8	D20 L150 CL8	8	12	20	150	10	26	M6

PORTA TESTINE FILETTATE (CPY)

EXTENTIONS FOR SCREWED MILLING CUTTERS

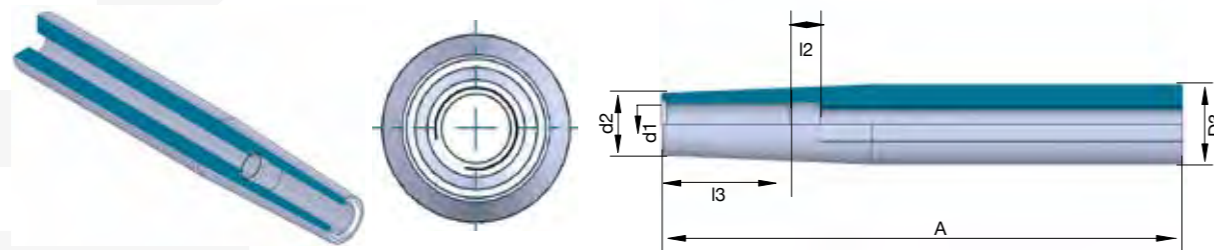

CALETTAMENTO A CALDO - CYLINDRICAL SHRINK FIT HOLDERS

Cod.	TYPE	d1	d2	D3	A	l2	l3	M
D20.150.CL10	D20 L150 CL10	10	14	20	150	10	32	M6
D20.150.CL12	D20 L150 CL12	12	16	20	150	10	37	M10
D25.150.CL8	D25 L150 CL8	8	20	25	150	10	26	M6
D25.150.CL10	D25 L150 CL10	10	20	25	150	10	32	M6
D25.150.CL12	D25 L150 CL12	12	20	25	150	10	37	M10
D25.150.CL14	D25 L150 CL14	14	20	25	150	10	37	M10
D25.150.CL16	D25 L150 CL16	16	22	25	150	10	40	M10
D32.150.CL10	D32 L150 CL10	10	24	32	150	10	32	M6
D32.150.CL12	D32 L150 CL12	12	24	32	150	10	37	M10
D32.150.CL14	D32 L150 CL14	14	27	32	150	10	37	M10
D32.150.CL16	D32 L150 CL16	16	27	32	150	10	40	M10
D32.150.CL18	D32 L150 CL18	18	27	32	150	10	40	M10
D32.150.CL20	D32 L150 CL20	20	27	32	150	10	42	M10

SU RICHIESTA: POSSIBILE FORNIRE LUNGHEZZA FINO A 500 MM
ON REQUEST: AVAILABLE UP TO LENGTH 500 MM

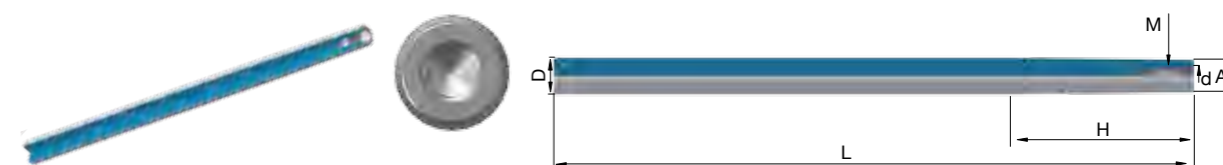

PORTA TESTINE FILETTATE - EXTENSIONS FOR SCREWED MILLING CUTTERS

Cod.	TYPE	H	M	d	A	D	L
D12.65.M5CPY	D.12 L65 M5 CPY	20	M5	5,5	10	12	65
D20.75.M6CPY	D.20 L75 M6 CPY	25	M6	6,5	10	20	75
D20.100.M6CPY	D.20 L100 M6 CPY	50	M6	6,5	10	20	100
D20.125.M6CPY	D.20 L125 M6 CPY	75	M6	6,5	10	20	125
D16.88.M8CPY	D.16 L88 M8 CPY	40	M8	8,5	12,8	16	88
D20.75.M8CPY	D.20 L75 M8 CPY	25	M8	8,5	12,8	20	75
D20.100.M8CPY	D.20 L100 M8 CPY	50	M8	8,5	12,8	20	100
D20.125.M8CPY	D.20 L125 M8 CPY	75	M8	8,5	12,8	20	125
D20.150.M8CPY	D.20 L150 M8 CPY	100	M8	8,5	12,8	20	150
D20.75.M10CPY	D.20 L75 M10 CPY	25	M10	10,5	17,8	20	75

PORTA PINZA ER DIN6499

CYLINDRICAL COLLET CHUCKS FOR ER DIN6499

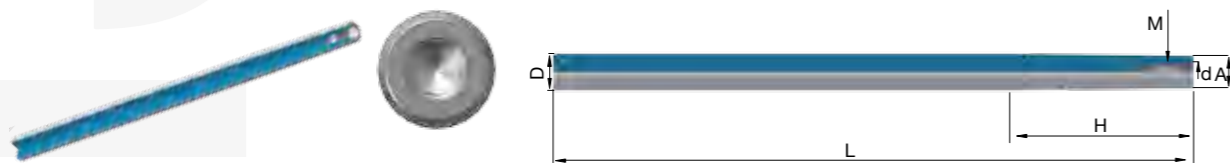

PORTA TESTINE FILETTATE - EXTENSIONS FOR SCREWED MILLING CUTTERS

Cod.	TYPE	H	M	d	A	D	L
D20.80.M10CPY	D.20 L80 M10 CPY	25	M10	10,5	17,8	20	80
D20.100.M10CPY	D.20 L100 M10 CPY	50	M10	10,5	17,8	20	100
D20.125.M10CPY	D.20 L125 M10 CPY	75	M10	10,5	17,8	20	125
D20.150.M10CPY	D.20 L150 M10 CPY	100	M10	10,5	17,8	20	150
D25.81.M12CPY	D.25 L81 M12 CPY	25	M12	12,5	20,8	25	81
D25.101.M12CPY	D.25 L101 M12 CPY	50	M12	12,5	20,8	25	101
D25.131.M12CPY	D.25 L131 M12 CPY	75	M12	12,5	20,8	25	131
D25.170.M12CPY	D.25 L170 M12 CPY	100	M12	12,5	20,8	25	170
D25.181.M12CPY	D.25 L181 M12 CPY	125	M12	12,5	20,8	25	181
D32.170.M12CPY	D.32 L170 M12 CPY	100	M12	17	28,8	32	170
D32.85.M16CPY	D.32 L85 M16 CPY	25	M16	17	28,8	32	85
D32.105.M16CPY	D.32 L105 M16 CPY	50	M16	17	28,8	32	105
D32.135.M16CPY	D.32 L135 M16 CPY	75	M16	17	28,8	32	135
D32.185.M16CPY	D.32 L185 M16 CPY	125	M16	17	28,8	32	185

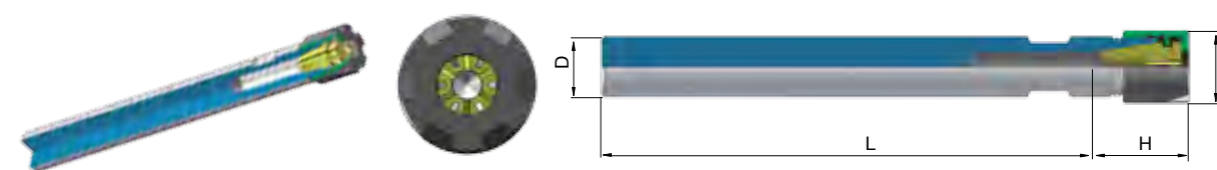

PORTAPINZE CILINDRICI PER ER MINI - CYLINDRICAL COLLETS CHUCK ER MINI

Cod.	TYPE	TOOL DIA.	H	A	D	L
D5.30.ER8M	D. 5 L30 ERX8M	1 ÷ 5 mm	25	12	5	30
D5.45.ER8M	D. 5 L45 ERX8M	1 ÷ 5 mm	25	12	5	45
D6.30.ER8M	D. 6 L30 ERX8M	1 ÷ 5 mm	25	12	6	30
D6.45.ER8M	D. 6 L45 ERX8M	1 ÷ 5 mm	25	12	6	45
D7.45.ER8M	D. 7 L45 ERX8M	1 ÷ 5 mm	25	12	7	45
D8.55.ER8M	D. 8 L55 ERX8M	1 ÷ 5 mm	25	12	8	55
D8.80.ER8M	D. 8 L80 ERX8M	1 ÷ 5 mm	25	12	8	80
D8.100.ER8M	D. 8 L100 ERX8M	1 ÷ 5 mm	25	12	8	100

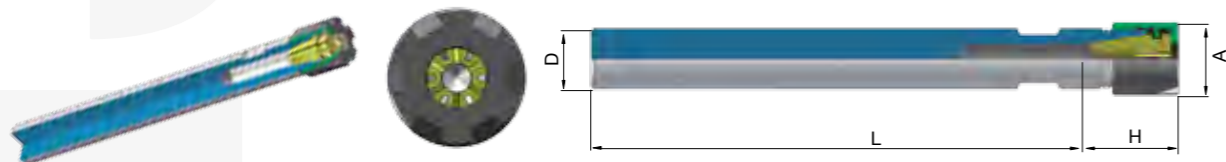

PORTAPINZE CILINDRICI PER ER MINI - CYLINDRICAL COLLETS CHUCK ER MINI

Cod.	TYPE	TOOL DIA.	H	A	D	L
D8.130.ER8M	D. 8 L130 ERX8M	1 ÷ 5 mm	25	12	8	130
D10.80.ER8M	D.10 L80 ERX8M	1 ÷ 5 mm	25	12	10	80
D10.100.ER8M	D.10 L100 ERX8M	1 ÷ 5 mm	19	12	10	100
D12.80.ER8M	D.12 L80 ERX8M	1 ÷ 5 mm	19	12	12	80
D12.100.ER8M	D.12 L100 ERX8M	1 ÷ 5 mm	19	12	12	100
D12.130.ER8M	D.12 L130 ERX8M	1 ÷ 5 mm	19	12	12	130
D12.160.ER8M	D.12 L160 ERX8M	1 ÷ 5 mm	19	12	12	160
D12.200.ER8M	D.12 L200 ERX8M	1 ÷ 5 mm	19	12	12	200



CASSETTA CON MANDRINO CILINDRICO - KIT

Cod.	Type Mandr.	Collets in Kit - 9 Pcs
B-MND0108-9	D.12 L100 ERX8M	1 ÷ 5 x 0,5 mm
B-MND0271-9	D.12 L130 ERX8M	1 ÷ 5 x 0,5 mm
B-MND0272-9	D.12 L160 ERX8M	1 ÷ 5 x 0,5 mm
B-MND0273-9	D.12 L200 ERX8M	1 ÷ 5 x 0,5 mm

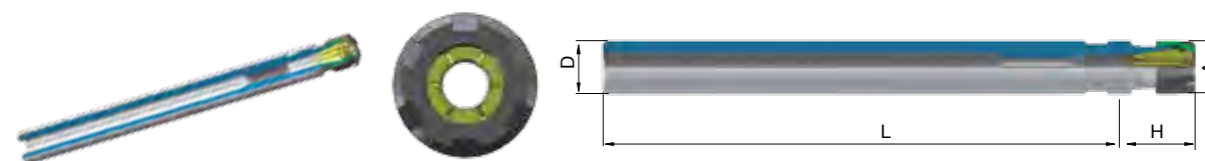

PORTAPINZE CILINDRICI PER ER MINI - CYLINDRICAL COLLETS CHUCK ER MINI

Cod.	TYPE	TOOL DIA.	H	A	D	L
D6.45.ER11M	D. 6 L45 ERX11M	1 ÷ 7 mm	37	16	6	45
D7.45.ER11M	D. 7 L45 ERX11M	1 ÷ 7 mm	37	16	7	45
D8.55.ER11M	D. 8 L55 ERX11M	1 ÷ 7 mm	26	16	8	55
D10.60.ER11M	D.10 L60 ERX11M	1 ÷ 7 mm	26	16	10	60
D10.100.ER11M	D.10 L100 ERX11M	1 ÷ 7 mm	26	16	10	100
D12.70.ER11M	D.12 L70 ERX11M	1 ÷ 7 mm	26	16	12	70
D12.100.ER11M	D.12 L100 ERX11M	1 ÷ 7 mm	26	16	12	100
D12.140.ER11M	D.12 L140 ERX11M	1 ÷ 7 mm	26	16	12	140
D16.40.ER11M	D.16 L40 ERX11M	1 ÷ 7 mm	19	16	16	40
D16.60.ER11M	D.16 L60 ERX11M	1 ÷ 7 mm	19	16	16	60
D16.100.ER11M	D.16 L100 ERX11M	1 ÷ 7 mm	19	16	16	100
D16.130.ER11M	D.16 L130 ERX11M	1 ÷ 7 mm	19	16	16	130
D16.160.ER11M	D.16 L160 ERX11M	1 ÷ 7 mm	19	16	16	160
D.16.200.ER11M	D.16 L200 ERX11M	1 ÷ 7 mm	19	16	16	200
D.16.250.ER11M	D.16 L250 ERX11M	1 ÷ 7 mm	19	16	16	250
D16.300.ER11M	D.16 L300 ERX11M	1 ÷ 7 mm	19	16	16	300
D20.70.ER11M	D.20 L70 ERX11M	1 ÷ 7 mm	19	16	20	70
D20.100.ER11M	D.20 L100 ERX11M	1 ÷ 7 mm	19	16	20	100
D20.130.ER11M	D.20 L130 ERX11M	1 ÷ 7 mm	19	16	20	130
D20.160.ER11M	D.20 L160 ERX11M	1 ÷ 7 mm	19	16	20	160
D25.100.ER11M	D.25 L100 ERX11M	1 ÷ 7 mm	19	16	25	100
D25.160.ER11M	D.25 L160 ERX11M	1 ÷ 7 mm	19	16	25	160

FORNIBILI ANCHE CON PIANO
ALSO AVAILABLE WITH FLAT

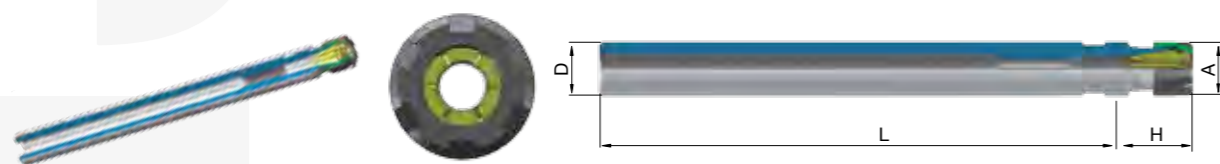

PORTAPINZE CILINDRICI PER ER MINI - CYLINDRICAL COLLETS CHUCK ER MINI

Cod.	TYPE	TOOL DIA.	H	A	D	L
MND1911	D.5/8" L2.5 ERX11M	1 ÷ 7 mm	.75	.629	5/8"	2.5
MND1448	D.5/8" L4.00 ERX11M	1 ÷ 7 mm	.75	.629	5/8"	4.00
MND0151	D.5/8" L5.11 ERX11M	1 ÷ 7 mm	.75	.629	5/8"	5.11
MND1463	D.3/4" L2.50 ERX11M	1 ÷ 7 mm	.75	.629	3/4"	2.50
MND1464	D.3/4" L3.93 ERX11M	1 ÷ 7 mm	.75	.629	3/4"	3.93
MND1465	D.3/4" L5.11 ERX11M	1 ÷ 7 mm	.75	.629	3/4"	5.11
MND1466	D.3/4" L6.30 ERX11M	1 ÷ 7 mm	.75	.629	3/4"	6.30

FORNIBILI ANCHE CON PIANO
ALSO AVAILABLE WITH FLAT



CASSETTA CON MANDRINO CILINDRICO - KIT

Cod.	Type Mandr.	Collets in Kit - 13 Pcs
B-MND0056-13	D.12 L100 ERX11M	D1 ÷ 7 x 0,5 mm
B-MND0012-13	D.16 L100 ERX11M	D1 ÷ 7 x 0,5 mm
B-MND0060-13	D.16 L130 ERX11M	D1 ÷ 7 x 0,5 mm
B-MND0005-13	D.16 L160 ERX11M	D1 ÷ 7 x 0,5 mm
B-MND0004-13	D.20 L100 ERX11M	D1 ÷ 7 x 0,5 mm
B-MND1209-13	D.25 L100 ERX11M	D1 ÷ 7 x 0,5 mm
B-MND0156-13	D.1/2" L4.00 ERX11M	D1 ÷ 7 x 0,5 mm
B-MND1448-13	D.5/8" L4.00 ERX11M	D1 ÷ 7 x 0,5 mm
B-MND1253-13	D.5/8" L6.00 ERX11M	D1 ÷ 7 x 0,5 mm

FORNIBILI ANCHE CON PIANO
ALSO AVAILABLE WITH FLAT

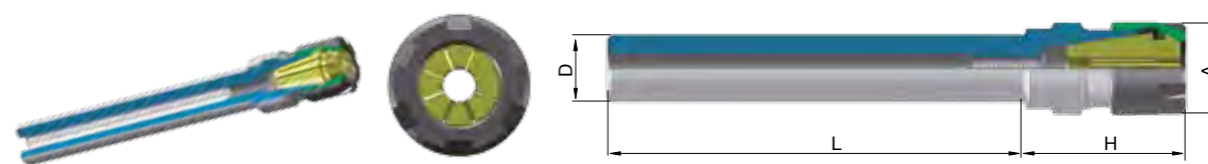

PORTAPINZE CILINDRICI PER ER MINI - CYLINDRICAL COLLETS CHUCK ER MINI

Cod.	TYPE	TOOL DIA.	H	A	D	L
D10.80.ER16M	D.10 L80 ERX16M	1 ÷ 10 mm	38	22	10	80
D12.80.ER16M	D.12 L80 ERX16M	1 ÷ 10 mm	38	22	12	80
D16.35.ER16M	D.16 L35 ERX16M	1 ÷ 10 mm	38	22	16	35
D16.80.ER16M	D.16 L80 ERX16M	1 ÷ 10 mm	38	22	16	80
D16.100.ER16M	D.16 L100 ERX16M	1 ÷ 10 mm	38	22	16	100
D16.130.ER16M	D.16 L130 ERX16M	1 ÷ 10 mm	38	22	16	130
D16.160.ER16M	D.16 L160 ERX16M	1 ÷ 10 mm	38	22	16	160
D16.200.ER16M	D.16 L200 ERX16M	1 ÷ 10 mm	38	22	16	200
D20.60.ER16M	D.20 L60 ERX16M	1 ÷ 10 mm	31	22	20	60
D20.100.ER16M	D.20 L100 ERX16M	1 ÷ 10 mm	31	22	20	100
D20.130.ER16M	D.20 L130 ERX16M	1 ÷ 10 mm	31	22	20	130
D20.160.ER16M	D.20 L160 ERX16M	1 ÷ 10 mm	31	22	20	160
D20.200.ER16M	D.20 L200 ERX16M	1 ÷ 10 mm	31	22	20	200
D20.270.ER16M	D.20 L270 ERX16M	1 ÷ 10 mm	31	22	20	270
D20.300.ER16M	D.20 L300 ERX16M	1-10 mm	31	22	20	300
D22.80.ER16M	D.22 L80 ERX16M	1 ÷ 10 mm	28	22	22	80
D25.60.ER16M	D.25 L60 ERX16M	1 ÷ 10 mm	28	22	25	60
D25.100.ER16M	D.25 L100 ERX16M	1 ÷ 10 mm	28	22	25	100
D25.130.ER16M	D.25 L130 ERX16M	1 ÷ 10 mm	28	22	25	130
D25.160.ER16M	D.25 L160 ERX16M	1 ÷ 10 mm	28	22	25	160
D32.90.ER16M	D.32 L90 ERX16M	1 ÷ 10 mm	28	22	32	90

FORNIBILI ANCHE CON PIANO
ALSO AVAILABLE WITH FLAT

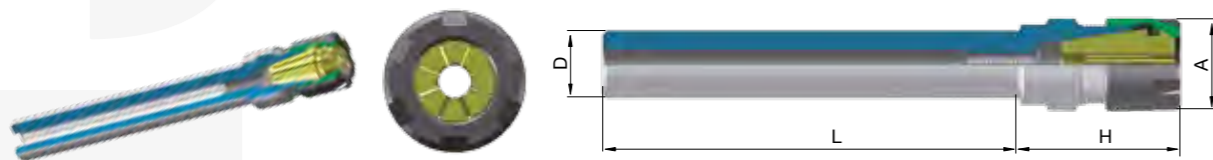

PORTAPINZE CILINDRICI PER ER MINI - CYLINDRICAL COLLETS CHUCK ER MINI

Cod.	TYPE	TOOL DIA.	H	A	D	L
MND0013	D1/2" L4.00 ERX16M	1 ÷ 10 mm	1.5	.866	1/2"	4.00
MND1251	D5/8" L3.93 ERX16M	1 ÷ 10 mm	1.5	.866	5/8"	3.93
MND1250	D5/8" L4.84 ERX16M	1 ÷ 10 mm	1.5	.866	5/8"	4.84
MND0031	D5/8" L5.11 ERX16M	1 ÷ 10 mm	1.5	.866	5/8"	5.11
MND1249	D5/8" L7.87 ERX16M	1 ÷ 10 mm	1.5	.866	5/8"	6.29
MND1445	D3/4" L2.50 ERX16M	1 ÷ 10 mm	1.1	.866	3/4"	2.50
MND1443	D3/4" L4.00 ERX16M	1 ÷ 10 mm	1.1	.866	3/4"	4.00
MND4829	D3/4" L5.11 ERX16M	1 ÷ 10 mm	1.1	.866	3/4"	5.11
MND0155	D3/4" L6.29 ERX16M	1 ÷ 10 mm	1.1	.866	3/4"	6.29
MND0084	D1" L2.36 ERX16M	1 ÷ 10 mm	1.1	.866	1"	2.36
MND0087	D1" L6.29 ERX16M	1 ÷ 10 mm	1.1	.866	1"	6.29

FORNIBILI ANCHE CON PIANO
ALSO AVAILABLE WITH FLAT

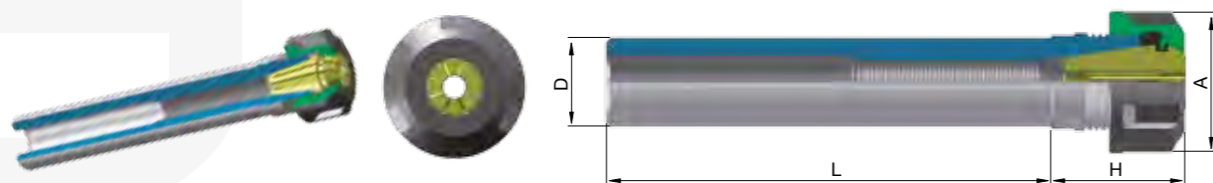

PORTAPINZE CILINDRICI PER ER MINI - CYLINDRICAL COLLETS CHUCK ER

Cod.	TYPE	TOOL DIA.	H	A	D	L
D16.35.ER16	D.16 L35 ERX16	1 ÷ 10 mm	38	32	16	35
D16.60.ER16	D.16 L60 ERX16	1 ÷ 10 mm	38	32	16	60
D16.160.ER16	D.16 L160 ERX16	1 ÷ 10 mm	38	32	16	160
D20.50.ER16	D.20 L50 ERX16	1 ÷ 10 mm	31	32	20	50
D20.60.ER16	D.20 L60 ERX16	1 ÷ 10 mm	31	32	20	60
D20.100.ER16	D.20 L100 ERX16	1 ÷ 10 mm	31	32	20	100
D20.160.ER16	D.20 L160 ERX16	1 ÷ 10 mm	31	32	20	160
D20.200.ER16	D.20 L200 ERX16	1 ÷ 10 mm	31	32	20	200

FORNIBILI ANCHE CON PIANO
ALSO AVAILABLE WITH FLAT

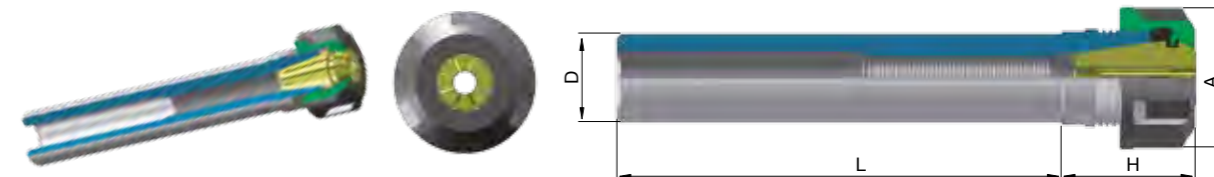

PORTAPINZE CILINDRICI PER ER MINI - CYLINDRICAL COLLETS CHUCK ER

Cod.	TYPE	TOOL DIA.	H	A	D	L
MND4830	D1/2" L2.36 ERX16	1 ÷ 10 mm	1.1	1.10	3/4"	2.36
MND4831	D3/4" L1.80 ERX16	1 ÷ 10 mm	1.1	1.10	3/4"	1.80
MND1445	D3/4" L2.50 ERX16	1 ÷ 10 mm	1.1	1.10	3/4"	2.50
MND1247	D3/4" L4.00 ERX16	1 ÷ 10 mm	1.1	1.10	3/4"	4.00
MND1203	D3/4" L6.00 ERX16	1 ÷ 10 mm	1.1	1.10	3/4"	6.00
MND0084	D1" L2.36 ERX16	1 ÷ 10 mm	1.1	1.10	1"	2.36
MND0086	D1" L5.11 ERX16	1 ÷ 10 mm	1.1	1.10	1"	5.11

FORNIBILI ANCHE CON PIANO
ALSO AVAILABLE WITH FLAT



CASSETTA CON MANDRINO CILINDRICO - KIT

Cod.	Type Mandr.	Collets in Kit - 10 Pcs
B-MND0007-10	D.12 L80 ERX16M	D1 ÷ 10 x 1,0 mm
B-MND0077-10	D.16 L100 ERX16M	D1 ÷ 10 x 1,0 mm
B-MND0078-10	D.16 L130 ERX16M	D1 ÷ 10 x 1,0 mm
B-MND0079-10	D.16 L160 ERX16M	D1 ÷ 10 x 1,0 mm
B-MND0080-10	D.16 L200 ERX16M	D1 ÷ 10 x 1,0 mm
B-MND0017-10	D.20 L100 ERX16M	D1 ÷ 10 x 1,0 mm
B-MND0082-10	D.20 L130 ERX16M	D1 ÷ 10 x 1,0 mm
B-MND0115-10	D.20 L160 ERX16M	D1 ÷ 10 x 1,0 mm
B-MND0083-10	D.20 L200 ERX16M	D1 ÷ 10 x 1,0 mm
B-MND0632-10	D.25 L100 ERX16M	D1 ÷ 10 x 1,0 mm
B-MND0633-10	D.25 L130 ERX16M	D1 ÷ 10 x 1,0 mm
B-MND0318-10	D.25 L160 ERX16M	D1 ÷ 10 x 1,0 mm
B-MND0031-10	D5/8" L5.11 ERX16M	D1 ÷ 10 x 1,0 mm
B-MND1443-10	D3/4" L4.00 ERX16M	D1 ÷ 10 x 1,0 mm
B-MND0155-10	D3/4" L6.29 ERX16M	D1 ÷ 10 x 1,0 mm

FORNIBILI ANCHE CON PIANO
ALSO AVAILABLE WITH FLAT

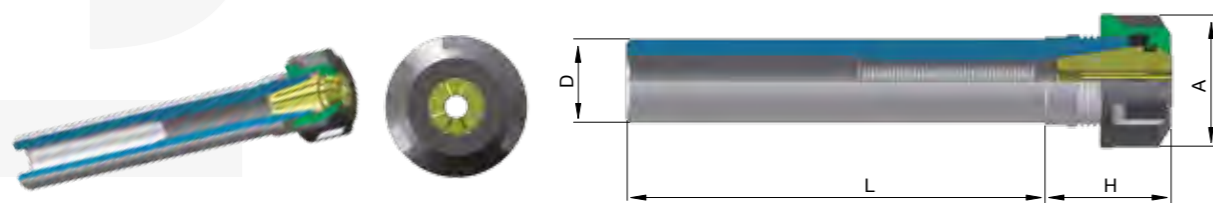

PORTAPINZE CILINDRICI PER ER - CYLINDRICAL COLLETS CHUCK ER MINI

Cod.	TYPE	TOOL DIA.	H	A	D	L
D16.100.ER20M	D.16 L100 ERX20M	1 ÷ 13 mm	42	28	16	100
D16.130.ER20M	D.16 L130 ERX20M	1 ÷ 13 mm	42	28	16	130
D16.160.ER20M	D.16 L160 ERX20M	1 ÷ 13 mm	42	28	16	160
D20.46.ER20M	D.20 L46 ERX20M	1 ÷ 13 mm	36	28	20	46
D20.60.ER20M	D.20 L60 ERX20M	1 ÷ 13 mm	36	28	20	60
D20.100.ER20M	D.20 L100 ERX20M	1 ÷ 13 mm	36	28	20	100
D20.130.ER20M	D.20 L130 ERX20M	1 ÷ 13 mm	36	28	20	130
D20.160.ER20M	D.20 L160 ERX20M	1 ÷ 13 mm	36	28	20	160
D20.200.ER20M	D.20 L200 ERX20M	1 ÷ 13 mm	36	28	20	200
D25.60.ER20M	D.25 L60 ERX20M	1 ÷ 13 mm	28	28	25	60
D25.130.ER20M	D.25 L130 ERX20M	1 ÷ 13 mm	28	28	25	130
D25.160.ER20M	D.25 L160 ERX20M	1 ÷ 13 mm	28	28	25	160
D25.240.ER20M	D.25 L240 ERX20M	1 ÷ 13 mm	28	28	25	240
D25.300.ER20M	D.25 L300 ERX20M	1 ÷ 13 mm	28	28	25	300
D32.95.ER20M	D.32 L95 ERX20M	1 ÷ 13 mm	28	28	32	95

FORNIBILI ANCHE CON PIANO
ALSO AVAILABLE WITH FLAT

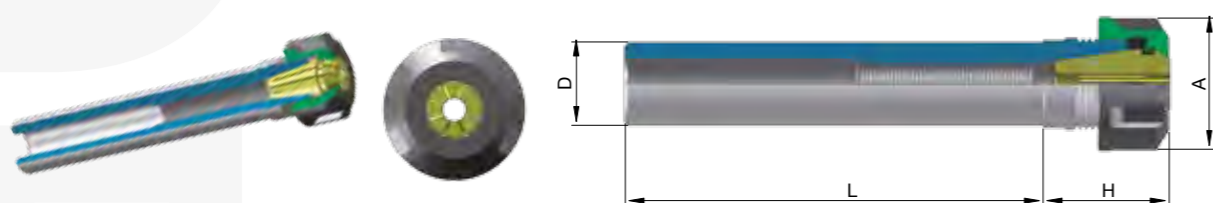

PORTAPINZE CILINDRICI PER ER - CYLINDRICAL COLLETS CHUCK ER MINI

Cod.	TYPE	TOOL DIA.	H	A	D	L
MND0152	D3/4" L2.50 ERX20M	1 ÷ 13 mm	1.41	1.10	3/4"	2.50
MND1446	D3/4" L4.00 ERX20M	1 ÷ 13 mm	1.41	1.10	3/4"	4.00
MND0319	D1" L3.93 ERX20M	1 ÷ 13 mm	1.41	1.10	1"	3.39
MND0963	D1" L5.50 ERX20M	1 ÷ 13 mm	1.41	1.10	1"	5.50

FORNIBILI ANCHE CON PIANO
ALSO AVAILABLE WITH FLAT

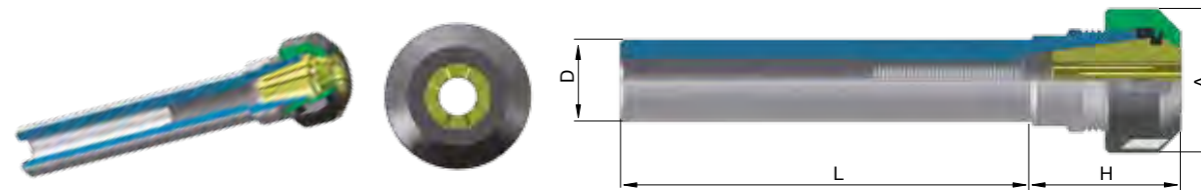

PORTAPINZE CILINDRICI PER ER - CYLINDRICAL COLLETS CHUCK ER

Cod.	TYPE	TOOL DIA.	H	A	D	L
D20.50.ER20	D.20 L50 ERX20	1 ÷ 13 mm	36	35	20	50
D20.60.ER20	D.20 L60 ERX20	1 ÷ 13 mm	36	35	20	60
D20.100.ER20	D.20 L100 ERX20	1 ÷ 13 mm	36	35	20	100
D20.130.ER20	D.20 L130 ERX20	1 ÷ 13 mm	36	35	20	130
D20.160.ER20	D.20 L160 ERX20	1 ÷ 13 mm	36	35	20	160
D20.200.ER20	D.20 L200 ERX20	1 ÷ 13 mm	36	35	20	200
D25.100.ER20	D.25 L100 ERX20	1 ÷ 13 mm	28	35	25	100

FORNIBILI ANCHE CON PIANO
ALSO AVAILABLE WITH FLAT

CASSETTA CON MANDRINO CILINDRICO - KIT



Cod.	Type Mandr.	Collets in Kit - 12 Pcs
B-MND0089-12	D.20 L100 ERX20M	D2 ÷ 13 x 1,0 mm
B-MND0090-12	D.20 L130 ERX20M	D2 ÷ 13 x 1,0 mm
B-MND0091-12	D.20 L160 ERX20M	D2 ÷ 13 x 1,0 mm
B-MND0092-12	D.20 L200 ERX20M	D2 ÷ 13 x 1,0 mm
B-MND0152-12	D3/4 L2.50 ERX20M	D2 ÷ 13 x 1,0 mm
B-MND1446-12	D3/4 L4.00 ERX20M	D2 ÷ 13 x 1,0 mm
B-MND0849-12	D3/4 L6.00 ERX20M	D2 ÷ 13 x 1,0 mm

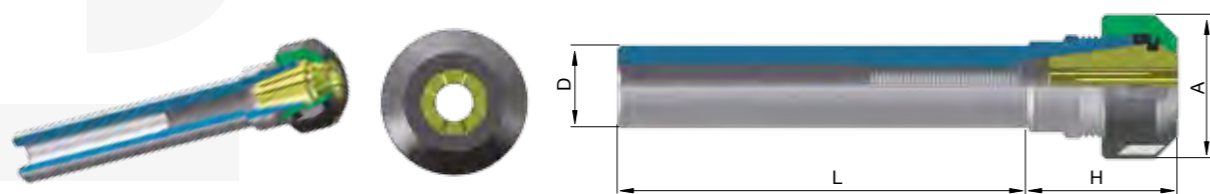

PORTAPINZE CILINDRICI PER ER - CYLINDRICAL COLLETS CHUCK ER

Cod.	TYPE	TOOL DIA.	H	A	D	L
MND1469	D3/4" L2.50 ERX20	1 ÷ 13 mm	1.41	1.33	3/4"	2.50
MND1470	D3/4" L3.93 ERX20	1 ÷ 13 mm	1.41	1.33	3/4"	3.93
MND1471	D3/4" L4.00 ERX20	1 ÷ 13 mm	1.41	1.33	3/4"	6.00
MND4832	D1" L1.96 ERX20	1 ÷ 13 mm	1.41	1.33	1"	1.96
MND4833	D1" L4.00 ERX20	1 ÷ 13 mm	1.41	1.33	1"	4.00
MND4834	D1" L5.11 ERX20	1 ÷ 13 mm	1.41	1.33	1"	5.11

FORNIBILI ANCHE CON PIANO
ALSO AVAILABLE WITH FLAT

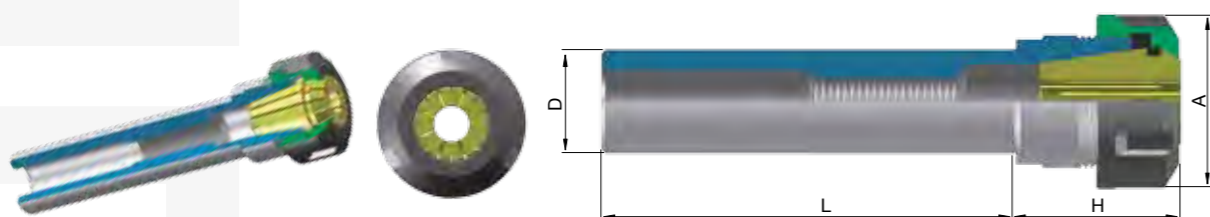

PORTAPINZE CILINDRICI PER ER - CYLINDRICAL COLLETS CHUCK ER MINI

Cod.	TYPE	TOOL DIA.	H	A	D	L
D20.46.ER25M	D.20 L46 ERX25M	1 ÷ 16 mm	46	35	20	46
D20.60.ER25M	D.20 L60 ERX25M	1 ÷ 16 mm	46	35	20	60
D20.100.ER25M	D.20 L100 ERX25M	1 ÷ 16 mm	46	35	20	100
D20.130.ER25M	D.20 L130 ERX25M	1 ÷ 16 mm	46	35	20	130
D20.160.ER25M	D.20 L160 ERX25M	1 ÷ 16 mm	46	35	20	160
D20.200.ER25M	D.20 L200 ERX25M	1 ÷ 16 mm	46	35	20	200
D25.70.ER25M	D.25 L70 ERX25M	1 ÷ 16 mm	40	35	25	70
D25.100.ER25M	D.25 L100 ERX25M	1 ÷ 16 mm	40	35	25	100
D25.130.ER25M	D.25 L130 ERX25M	1 ÷ 16 mm	40	35	25	130
D25.160.ER25M	D.25 L160 ERX25M	1 ÷ 16 mm	40	35	25	160
D25.260.ER25M	D.25 L260 ERX25M	1 ÷ 16 mm	40	35	25	260

FORNIBILI ANCHE CON PIANO
ALSO AVAILABLE WITH FLAT

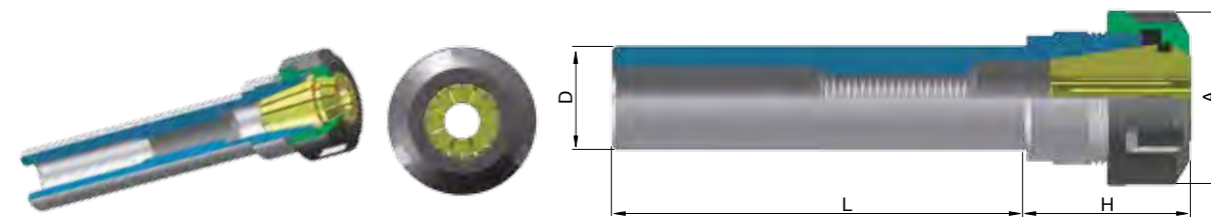

PORTAPINZE CILINDRICI PER ER - CYLINDRICAL COLLETS CHUCK ER MINI

Cod.	TYPE	TOOL DIA.	H	A	D	L
MND0126	D 1" L5.11 ERX25M	1 ÷ 16 mm	1.57	1.37	1"	5.11
MND1254	D 1" L6.30 ERX25M	1 ÷ 16 mm	1.57	1.37	1"	6.30

FORNIBILI ANCHE CON PIANO
ALSO AVAILABLE WITH FLAT

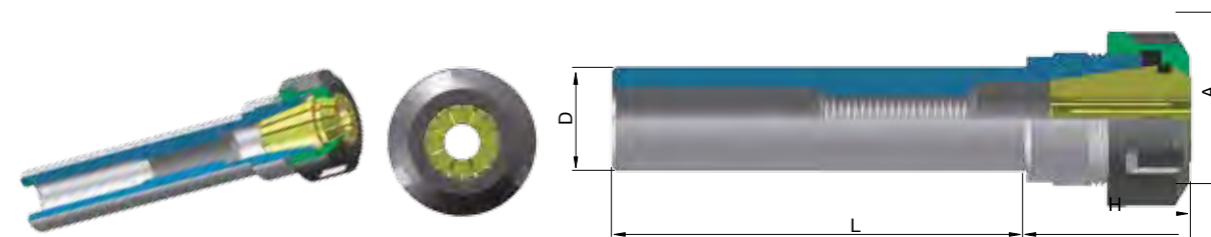

PORTAPINZE CILINDRICI PER ER - CYLINDRICAL COLLETS CHUCK ER

Cod.	TYPE	TOOL DIA.	H	A	D	L
D20.50.ER25	D.20 L50 ERX25	1 ÷ 16 mm	46	42	20	50
D20.60.ER25	D.20 L60 ERX25	1 ÷ 16 mm	46	42	20	60
D20.100.ER25	D.20 L100 ERX25	1 ÷ 16 mm	46	42	20	100
D20.130.ER25	D.20 L130 ERX25	1 ÷ 16 mm	46	42	20	130
D20.160.ER25	D.20 L160 ERX25	1 ÷ 16 mm	46	42	20	160
D25.50.ER25	D.25 L50 ERX25	1 ÷ 16 mm	40	42	25	50
D25.70.ER25	D.25 L70 ERX25	1 ÷ 16 mm	40	42	25	70
D25.100.ER25	D.25 L100 ERX25	1 ÷ 16 mm	40	42	25	100
D25.130.ER25	D.25 L130 ERX25	1 ÷ 16 mm	40	42	25	130
D25.160.ER25	D.25 L160 ERX25	1 ÷ 16 mm	40	42	25	160
D32.80.ER25	D.32 L80 ERX25	1 ÷ 16 mm	27	42	32	80
D32.100.ER25	D.32 L100 ERX25	1 ÷ 16 mm	27	42	32	100
D40.80.ER25	D.40 L80 ERX25	1 ÷ 16 mm	27	42	40	80

FORNIBILI ANCHE CON PIANO
ALSO AVAILABLE WITH FLAT

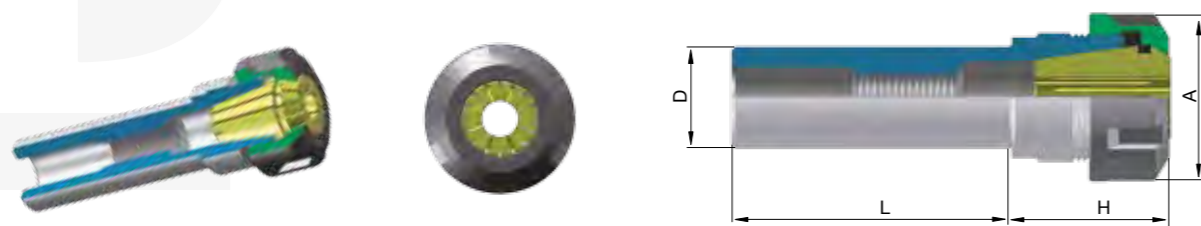

PORTAPINZE CILINDRICI PER ER - CYLINDRICAL COLLETS CHUCK ER

Cod.	TYPE	TOOL DIA.	H	A	D	L
MND1916	D3/4" L2.50 ERX25	1 ÷ 16 mm	1.81	1.65	3/4"	2.50
MND1457	D3/4" L4.00 ERX25	1 ÷ 16 mm	1.81	1.65	3/4"	4.00
MND1245	D1" L2.00 ERX25	1 ÷ 16 mm	1.57	1.65	1"	2.00
MND0359	D1" L3.93 ERX25	1 ÷ 16 mm	1.57	1.65	1"	3.93
MND1244	D1" L5.11 ERX25	1 ÷ 16 mm	1.57	1.65	1"	5.11
MND1917	D1"1/4" L2.00 ERX25	1 ÷ 16 mm	1.06	1.65	1" 1/4"	2.00
MND1918	D1"1/2" L3.14 ERX25	1 ÷ 16 mm	1.06	1.65	1" 1/2"	3.14
MND1424	D1"3/4" L5.11 ERX25	1 ÷ 16 mm	1.06	1.65	1" 3/4"	5.11

FORNIBILI ANCHE CON PIANO
ALSO AVAILABLE WITH FLAT



CASSETTA CON MANDRINO CILINDRICO - KIT

Cod.	Type Mandr.	Collets in Kit - 15 Pcs
B-MND0114-15	D.20 L100 ERX25M	D2 ÷ 16 x 1,0 mm
B-MND0838-15	D.20 L130 ERX25M	D2 ÷ 16 x 1,0 mm
B-MND0358-15	D.20 L160 ERX25M	D2 ÷ 16 x 1,0 mm
B-MND0328-15	D.20 L200 ERX25M	D2 ÷ 16 x 1,0 mm
B-MND0556-15	D.25 L100 ERX25M	D2 ÷ 16 x 1,0 mm
B-MND0125-15	D.25 L160 ERX25M	D2 ÷ 16 x 1,0 mm
B-MND0159-15	D.20 L50 ERX25	D2 ÷ 16 x 1,0 mm
B-MND0634-15	D.25 L100 ERX25	D2 ÷ 16 x 1,0 mm
B-MND0164-15	D.32 L80 ERX25	D2 ÷ 16 x 1,0 mm
B-MND1455-15	D3/4" L2.00 ERX25	D2 ÷ 16 x 1,0 mm
B-MND1457-15	D3/4" L4.00 ERX25	D2 ÷ 16 x 1,0 mm
B-MND1245-15	D1" L2.00 ERX25	D2 ÷ 16 x 1,0 mm

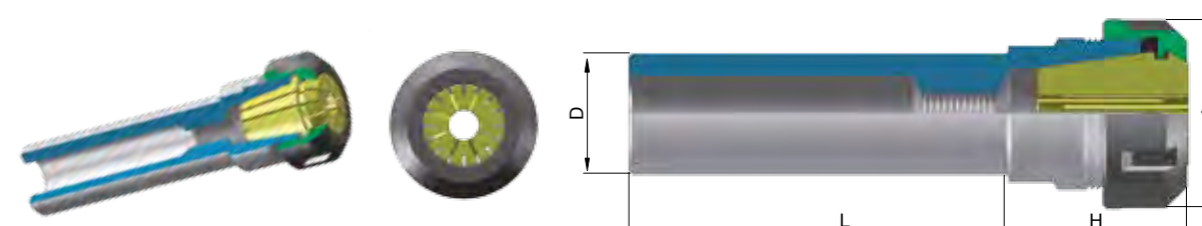

PORTAPINZE CILINDRICI PER ER - CYLINDRICAL COLLETS CHUCK ER

Cod.	TYPE	TOOL DIA.	H	A	D	L
D20.50.ER32	D.20 L50 ERX32	2 ÷ 20 mm	53	50	20	50
D20.100.ER32	D.20 L100 ERX32	2 ÷ 20 mm	53	50	20	100
D20.130.ER32	D.20 L130 ERX32	2 ÷ 20 mm	53	50	20	130
D20.160.ER32	D.20 L160 ERX32	2 ÷ 20 mm	53	50	20	160
D25.50.ER32	D.25 L50 ERX32	2 ÷ 20 mm	53	50	25	50
D25.70.ER32	D.25 L70 ERX32	2 ÷ 20 mm	53	50	25	70
D25.100.ER32	D.25 L100 ERX32	2 ÷ 20 mm	53	50	25	100
D25.130.ER32	D.25 L130 ERX32	2 ÷ 20 mm	53	50	25	130
D25.160.ER32	D.25 L160 ERX32	2 ÷ 20 mm	53	50	25	160
D32.50.ER32	D.32 L50 ERX32	2 ÷ 20 mm	48	50	32	50
D32.70.ER32	D.32 L70 ERX32	2 ÷ 20 mm	48	50	32	70
D32.100.ER32	D.32 L100 ERX32	2 ÷ 20 mm	48	50	32	100
D32.130.ER32	D.32 L130 ERX32	2 ÷ 20 mm	48	50	32	130
D32.160.ER32	D.32 L160 ERX32	2 ÷ 20 mm	48	50	32	160
D40.80.ER32	D.40 L80 ERX32	2 ÷ 20 mm	33	50	40	80
D40.130.ER32	D.40 L130 ERX32	2 ÷ 20 mm	33	50	40	130
D40.160.ER32	D.40 L160 ERX32	2 ÷ 20 mm	33	50	40	160
D50.160.ER32	D.50 L160 ERX32	2 ÷ 20 mm	33	50	50	160
D60.160.ER32	D.60 L160 ERX32	2 ÷ 20 mm	33	50	60	160

FORNIBILI ANCHE CON PIANO
ALSO AVAILABLE WITH FLAT

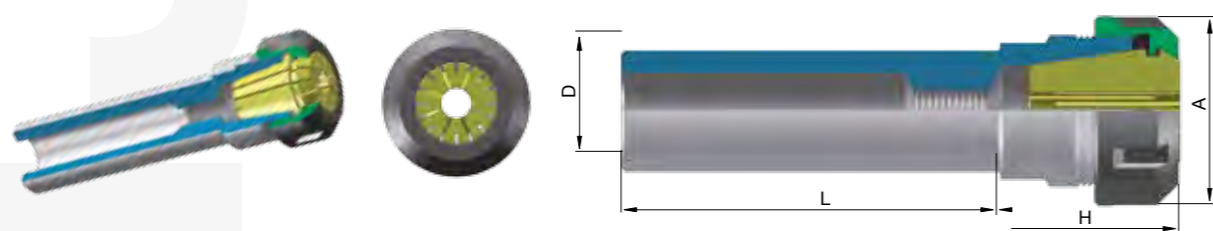

PORTAPINZE CILINDRICI PER ER - CYLINDRICAL COLLETS CHUCK ER

Cod.	TYPE	TOOL DIA.	H	A	D	L
MND0786	D3/4 L2.12 ERX32	2 ÷ 20 mm	2.08	1.96	3/4	2.12
MND0787	D1" L2.00 ERX32	2 ÷ 20 mm	2.08	1.96	1"	2.00
MND1240	D1" L3.93 ERX32	2 ÷ 20 mm	2.08	1.96	1"	3.93
MND1241	D1" L5.11 ERX32	2 ÷ 20 mm	2.08	1.96	1"	5.11
MND1242	D1" L6.30 ERX32	2 ÷ 20 mm	2.08	1.96	1"	6.30
MND1472	D1" 1/4" L2.35 ERX32	2 ÷ 20 mm	1.85	1.96	1" 1/4"	2.35
MND1919	D1" 1/2" L3.14 ERX32	2 ÷ 20 mm	1.30	1.96	1" 1/2"	3.14
MND1921	D1" 3/4" L3.14 ERX32	2 ÷ 20 mm	1.30	1.96	1" 3/4"	3.14
MND1922	D1" 3/4" L5.11 ERX32	2 ÷ 20 mm	1.30	1.96	1" 3/4"	5.11
MND1450	D2" L3.14 ERX32	2 ÷ 20 mm	1.30	1.96	2"	3.14
MND1425	D2" L6.30 ERX32	2 ÷ 20 mm	1.30	1.96	2"	6.30
MND1923	D2" 1/2 L6.30 ERX32	2 ÷ 20 mm	1.30	1.96	2" 1/2"	6.30

FORNIBILI ANCHE CON PIANO
ALSO AVAILABLE WITH FLAT



CASSETTA CON MANDRINO CILINDRICO - KIT

Cod.	Type Mandr.	Collets in Kit - ERX32
B-MND0593-6	D.20 L50 ERX32	6 pcs.
B-MND0195-6	D.25 L50 ERX32	6 pcs.
B-MND0071-6	D.32 L70 ERX32	6 pcs.
B-MND0593-9	D.20 L50 ERX32	9 pcs.
B-MND0195-9	D.25 L50 ERX32	9 pcs.
B-MND0071-9	D.32 L70 ERX32	9 pcs.
B-MND0593-18	D.20 L50 ERX32	18 pcs.
B-MND0195-18	D.25 L50 ERX32	18 pcs.
B-MND0071-18	D.32 L70 ERX32	18 pcs.
B-MND0786-11	D.3/4" L2.12 ERX32	11 pcs.
B-MND0787-11	D1" L2.00 ERX32	11 pcs.
B-MND1240-11	D1" L3.93 ERX32	11 pcs.
B-MND1472-11	D1" 1/4" L2.35 ERX32	11 pcs.

FORNIBILI ANCHE CON PIANO
ALSO AVAILABLE WITH FLAT

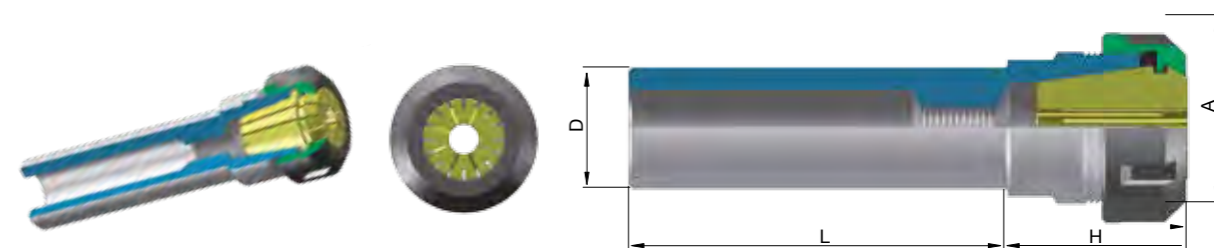

PORTAPINZE CILINDRICI PER ER - CYLINDRICAL COLLETS CHUCK ER

Cod.	TYPE	TOOL DIA.	H	A	D	L
D25.60.ER40	D.25 L60 ERX40	3 ÷ 30 mm	60	63	25	60
D25.100.ER40	D.25 L100 ERX40	3 ÷ 30 mm	60	63	25	100
D32.70.ER40	D.32 L70 ERX40	3 ÷ 30 mm	60	63	32	70
D32.100.ER40	D.32 L100 ERX40	3 ÷ 30 mm	60	63	32	100
D32.130.ER40	D.32 L130 ERX40	3 ÷ 30 mm	60	63	32	130
D40.80.ER40	D.40 L80 ERX40	3 ÷ 30 mm	50	63	40	80
D40.130.ER40	D.40 L130 ERX40	3 ÷ 30 mm	50	63	40	130
D40.160.ER40	D.40 L160 ERX40	3 ÷ 30 mm	50	63	40	160
D50.120.ER40	D.50 L120 ERX40	3 ÷ 30 mm	35	63	50	120
D50.160.ER40	D.50 L160 ERX40	3 ÷ 30 mm	35	63	50	160
D60.160.ER40	D.60 L160 ERX40	3 ÷ 30 mm	35	63	60	160

FORNIBILI ANCHE CON PIANO
ALSO AVAILABLE WITH FLAT

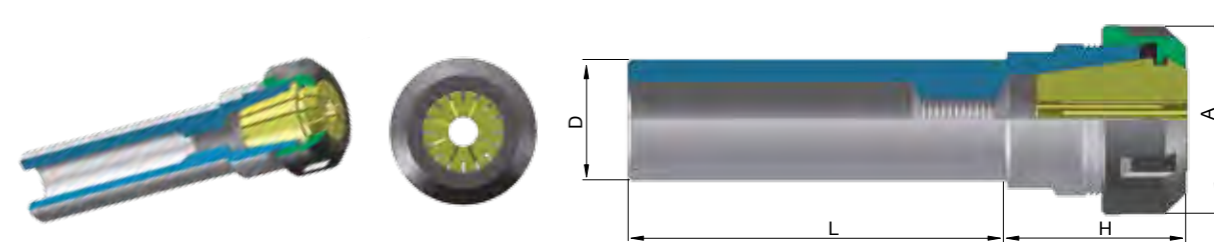

PORTAPINZE CILINDRICI PER ER - CYLINDRICAL COLLETS CHUCK ER

Cod.	TYPE	TOOL DIA.	H	A	D	L
MND0825	D.1" L2.36 ERX40	3 ÷ 30 mm	2.36	2.48	1"	2.36
MND1243	D.1" L3.93 ERX40	3 ÷ 30 mm	2.36	2.48	1"	3.93
MND1255	D.1" 1/4" L2.00 ERX40	3 ÷ 30 mm	2.36	2.48	1" 1/4"	2.00
MND0568	D.1" 1/4" L2.36 ERX40	3 ÷ 30 mm	2.36	2.48	1" 1/4"	2.36
MND1252	D.2" L6.30 ERX40	3 ÷ 30 mm	1.37	2.48	2"	6.30
MND1925	D.2" 1/4" L6.30 ERX40	3 ÷ 30 mm	1.37	2.48	2" 1/4"	6.30
MND1926	D.2" 1/2" L6.30 ERX40	3 ÷ 30 mm	1.37	2.48	2" 1/2"	6.30

FORNIBILI ANCHE CON PIANO
ALSO AVAILABLE WITH FLAT



CASSETTA CON MANDRINO CILINDRICO - KIT

Cod.	Type Mandr.	Collets in Kit - ERX40
B-MND0822-7	D.25 L60 ERX40	7 pcs.
B-MND0601-7	D.32 L70 ERX40	7 pcs.
B-MND0247-7	D.40 L80 ERX40	7 pcs.
B-MND0822-13	D.25 L60 ERX40	13 pcs.
B-MND0601-13	D.32 L70 ERX40	13 pcs.
B-MND0247-13	D.40 L80 ERX40	13 pcs.
B-MND0822-23	D.25 L60 ERX40	23 pcs.
B-MND0601-23	D.32 L70 ERX40	23 pcs.
B-MND0247-23	D.40 L80 ERX40	23 pcs.
B-MND0825-15	D.1"L2.36 ERX40	15 pcs.

FORNIBILI ANCHE CON PIANO
ALSO AVAILABLE WITH FLAT